

puerta y decoración en perfecta armonía

door and decoration in perfect harmony / décor et porte en parfaite harmonie

*Nuestra historia,  
nuestro mejor aval.*



block  
**ARTEVI**





serie  
**lisa**

LISA, LISAT //04-07//



serie  
**deco**

DECO-DECON-DECOT-DECOTS-  
DELIU-AL DECO...//08-15//



serie  
**líneas**

MAPIT - MARA - MAR 5 - CALA ...//16-23//



serie  
moldura  
**plana** tm

31MPTM - 34MPTM - 72MPTM //24-27//



serie  
moldura  
**clásica** tm

102TM - 1103TM - 103TM - 32TM - 52TM  
62TM - 72TM //28-39//



# Índice *Index*



## serie lacado

B2032E - B2104E - B2103F - B2052E  
B2072E - MARA - MAR 5 - MAPI - MAHO  
EÑE...//40-57//



## serie melamina

LISAT SIBERIA - LISAT AHUMADO  
LISA NORDICO - LISAT GRAFITO  
LISAT NOGAL - LISA ROBLE //58-61//



## acabados

MADERA NATURAL - LACADO - ECO - MELAMINA //62-63//



puertas técnicas resistentes  
al fuego y con atenuación acústica

El<sub>2</sub>30 - El<sub>2</sub>60 - El<sub>2</sub>90 - El<sub>2</sub>120 - El<sub>2</sub>30dB - El<sub>2</sub>60dB //64-67//



# LISA

\_haya vaporizada  
\_steamed beech  
\_hêtre étuvé

serie  
lisa





# LISA

\_haya vaporizada  
\_steamed beech  
\_hêtre étuvé

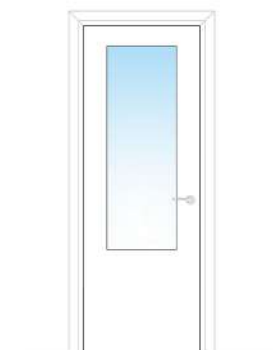

LISA IV

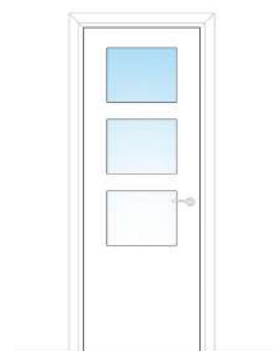

LISA 3VLL

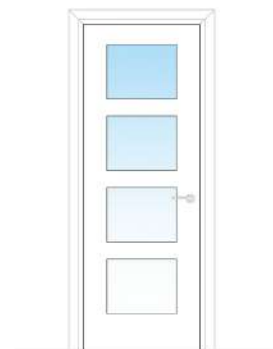

LISA 4VLL

\_tipo de vidrieras  
\_types of glass door  
\_les types de portes en verre



# LISAT

\_roble  
\_oak  
\_chêne

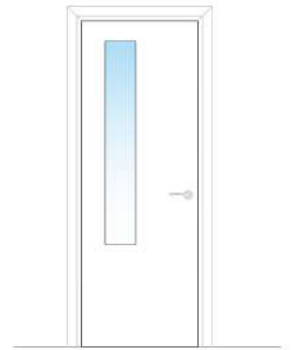

LISA 1VL

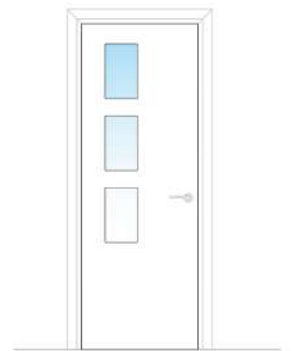

LISA 3VL

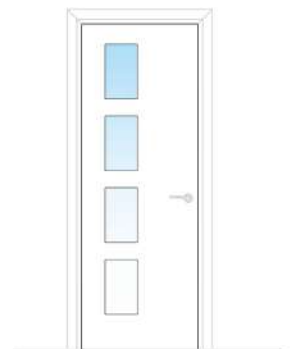

LISA 4VL

\_tipo de vidrieras  
\_types of glass door  
\_les types de portes en verre





DECO TS

\_roble  
\_oak  
\_chêne

serie  
deco





# DECO TS

\_roble  
\_oak  
\_chêne

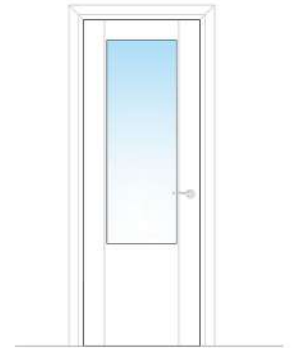

DECO TS IV

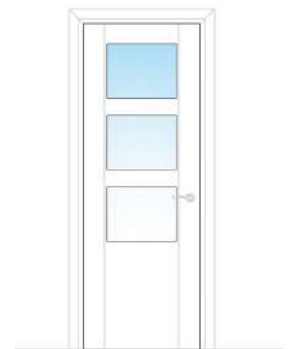

DECO TS 3VLL

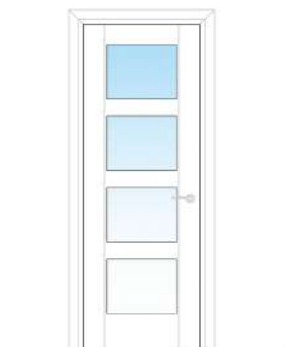

DECO TS 4VLL

\_tipo de vidrieras  
\_types of glass door  
\_les types de portes en verre

# detalles de marquetería

marquetry detail  
détail de la marqueterie

DECO

## VETA VERTICAL

middle panel vertical grain  
panneau central avec veine verticale

## VETA TRANSVERSAL

middle panel transversal grain  
panneau central avec veine transversale



\_DECOTS sin marquetería  
without marquetry / sans marqueterie



\_DECO marquetería blanca  
white marquetry / marqueterie blanche



\_DECOT marquetería blanca  
white marquetry / marqueterie blanche



\_DECON marquetería negra  
black marquetry / marqueterie noire



\_DECONT marquetería negra  
black marquetry / marqueterie noire



\_DECOU marquetería ukola  
ukola marquetry / marqueterie ukola



\_DECOUT marquetería ukola  
ukola marquetry / marqueterie ukola



# DECO

\_roble  
\_oak  
\_chêne

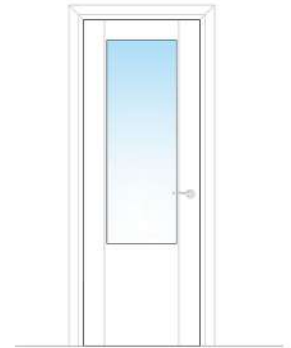

DECO IV

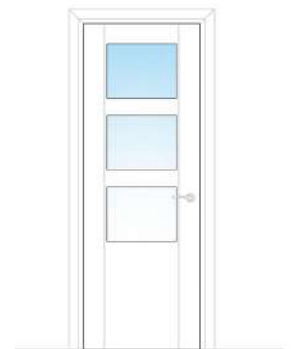

DECO 3VLL

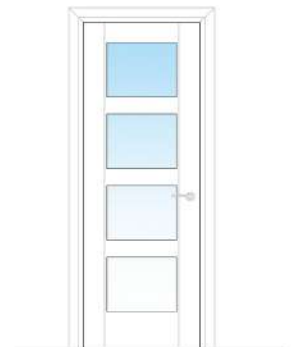

DECO 4VLL

\_tipo de vidrieras  
\_types of glass door  
\_les types de portes en verre



## DECO T

\_haya vaporizada  
\_steamed beech  
\_hêtre étuvé

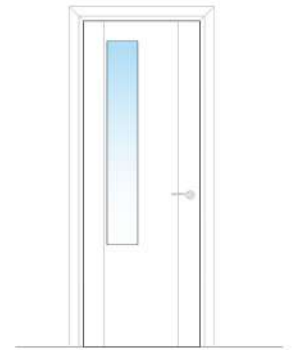

DECO T 1VL

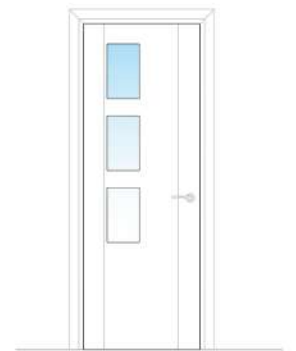

DECO T 3VL

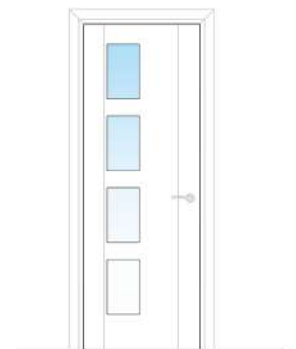

DECO T 4VL

\_tipo de vidrieras  
\_types of glass door  
\_les types de portes en verre



# DECON

\_cedro  
\_cedar  
\_cèdre

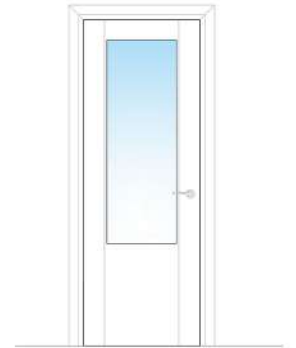

DECON IV

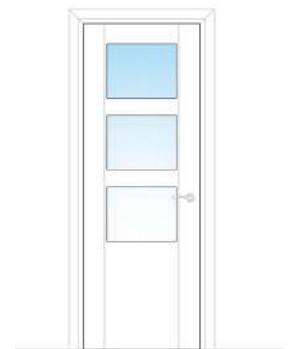

DECON 3VLL

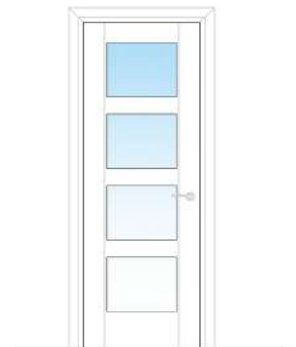

DECON 4VLL

\_tipo de vidrieras  
\_types of glass door  
\_les types de portes en verre



## DECO UT

\_roble  
\_oak  
\_chêne

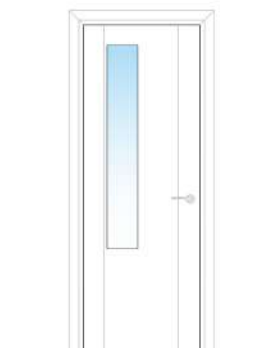

DECO NT 1VL

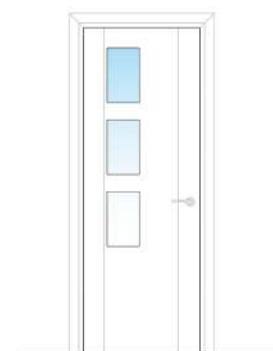

DECO NT 3VL

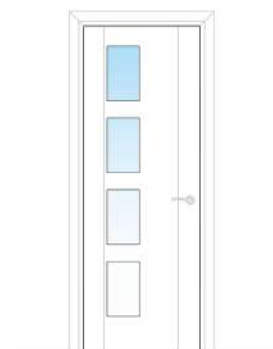

DECO NT 4VL

\_tipo de vidrieras  
\_types of glass door  
\_les types de portes en verre





MAPIT

\_sapelly rameado  
\_crown sapele  
\_sapelli fleuri

serie  
lineas





# CALA

\_haya vaporizada  
\_steamed beech  
\_hêtre étuvé

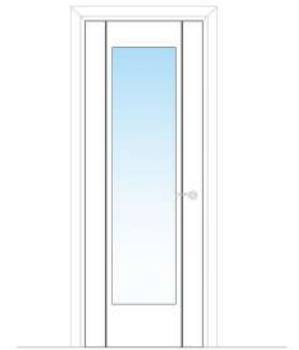

CALA IV

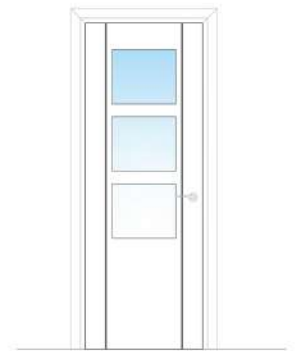

CALA 3VLL

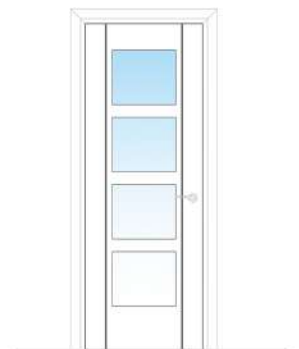

CALA 4VLL

\_tipo de vidrieras  
\_types of glass door  
\_les types de portes en verre

\_FRESADO EN PICO DE CORRIÓN  
sparrow beak milling / fraisage de bec de moineau

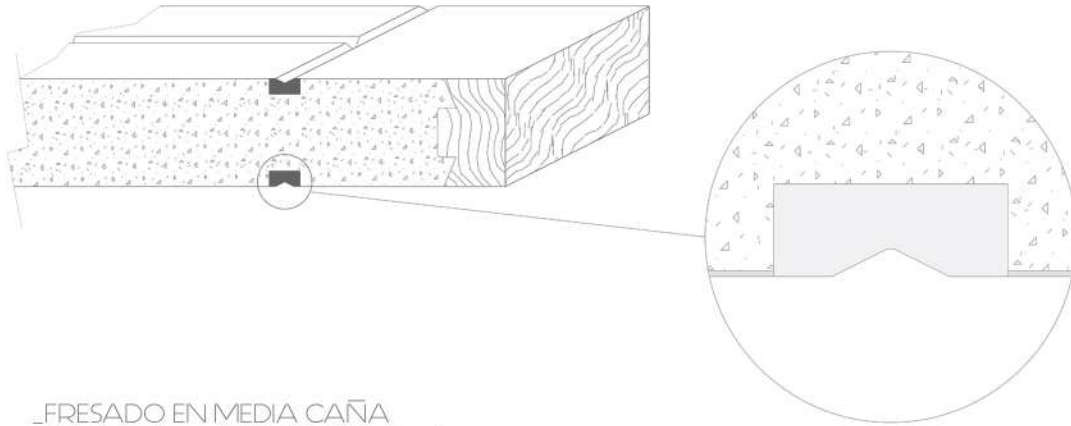

\_FRESADO EN MEDIA CAÑA  
milling in half cane / freisane en demi canne

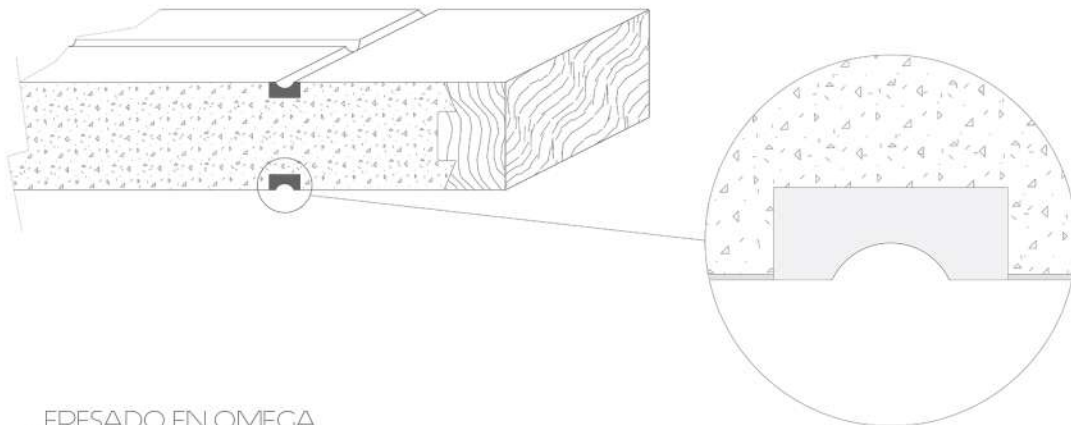

\_FRESADO EN OMEGA  
omega peak milling / fraisage de bec de omega

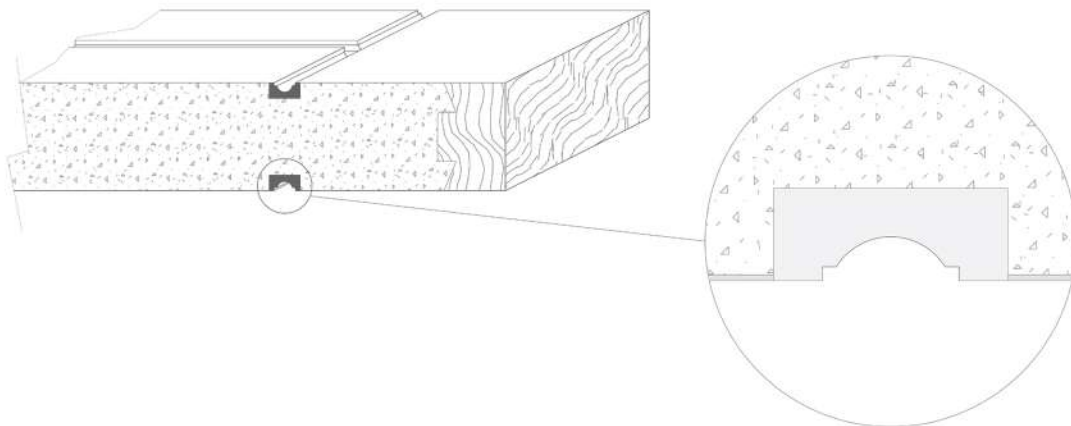



# MAPI

\_cedro romeado  
\_crown cedar  
\_cèdre fleuri

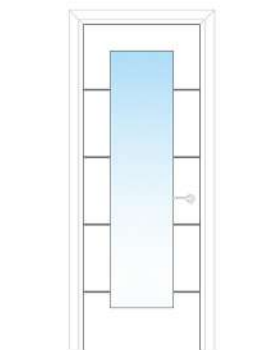

MAPI IV

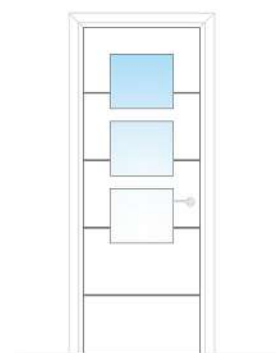

MAPI 3VLL

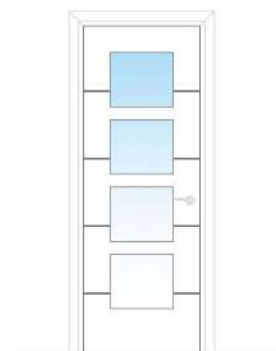

MAPI 4VLL

\_tipo de vidrieras  
\_types of glass door  
\_les types de portes en verre



# MAPIT

- \_sapelli rameado
- \_crown sapele
- \_sapelli fleuri

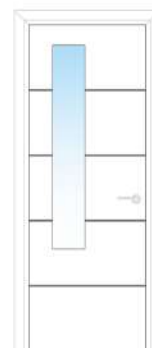

MAPIT 5 1VL

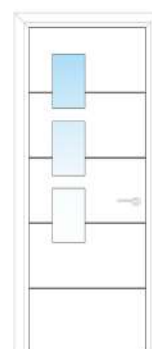

MAPIT 5 3VL

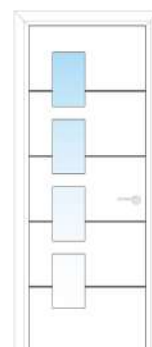

MAPIT 5 4VL

- \_tipo de vidrieras
- \_types of glass door
- \_les types de portes en verre



# MARA

\_roble  
\_oak  
\_chêne

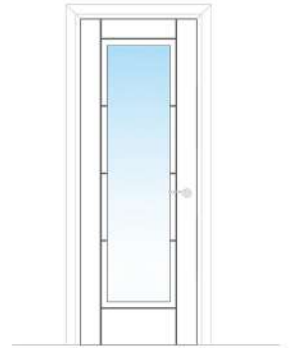

MARA 1VLL

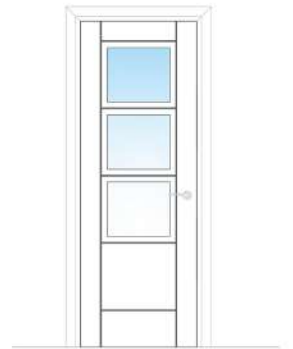

MARA 2VLL

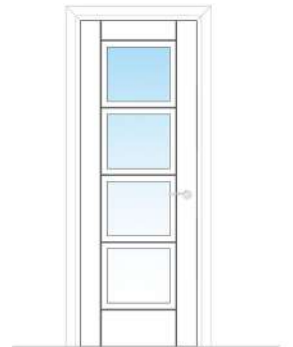

MARA 3VLL

\_tipo de vidrieras  
\_types of glass door  
\_les types de portes en verre



# MAR 5

\_roble  
\_oak  
\_chêne

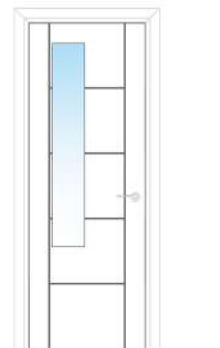

MAPI 5 IVL

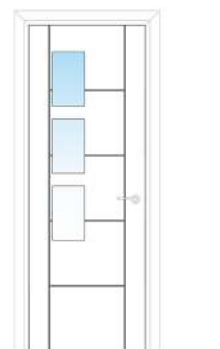

MAPI 5 3VL

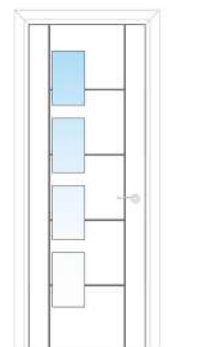

MAPI 5 4VL

\_tipo de vidrieras  
\_types of glass door  
\_les types de portes en verre





34 MP TM

\_haya vaporizada  
\_steamed beech  
\_hêtre étuvé

serie

mp

moldura plana

plain moulding  
moulure plat





## 72 MP TM

\_roble  
\_oak  
\_chêne

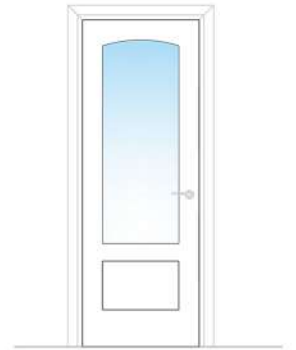

72 V MP TM

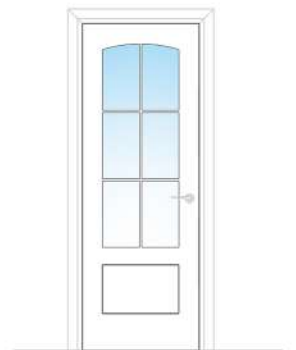

76 V MP TM

\_tipo de vidrieras  
\_types of glass door  
\_les types de portes en verre



## 31 MP TM

\_roble  
\_oak  
\_chêne

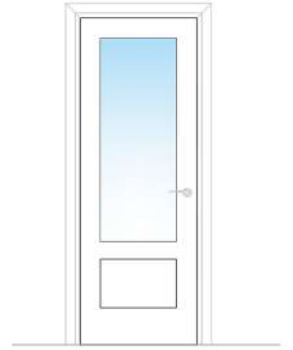

31 V MP TM

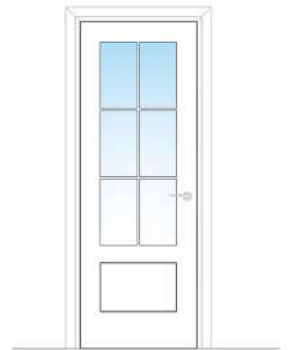

316 V MP TM

\_tipo de vidrieras  
\_types of glass door  
\_les types de portes en verre



31 TM

\_roble  
\_oak  
\_chêne



serie

tm

moldura clásica

curve moulding  
moulure curve



## 52 TM

\_roble  
\_oak  
\_chêne

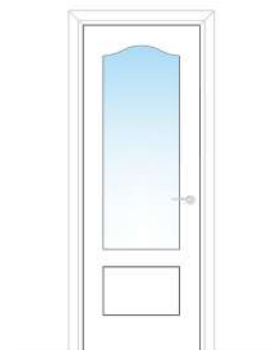

52 V TM

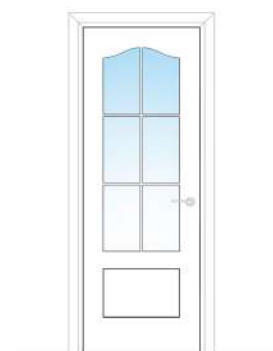

56 V TM

\_tipo de vidrieras  
\_types of glass door  
\_les types de portes en verre



52 ITM

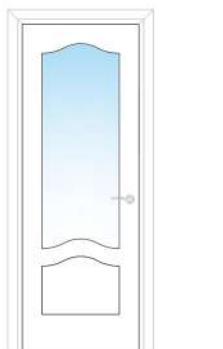

52 V ITM

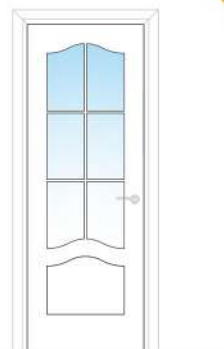

56 V ITM



52 ETM

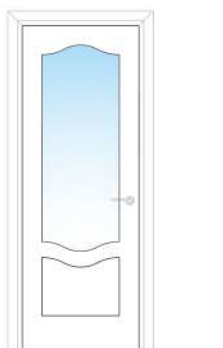

52 V ETM

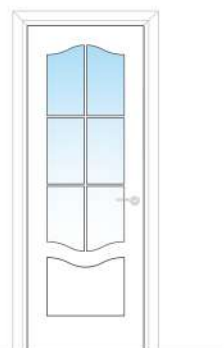

56 V ETM



52 HTM

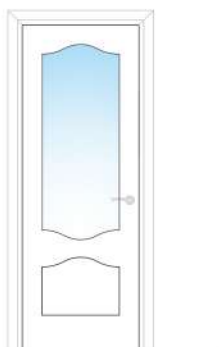

52 V HTM

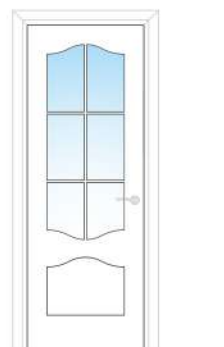

56 V HTM

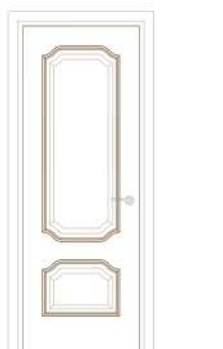

52 JTM

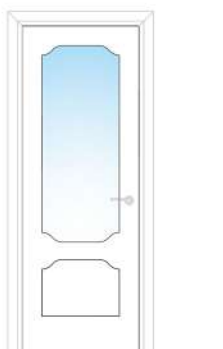

52 V JTM

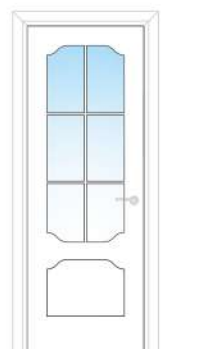

56 V JTM



## 62 TM

\_roble  
\_oak  
\_chêne

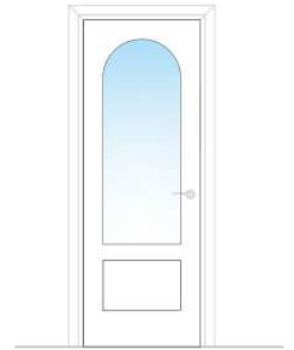

62 V TM

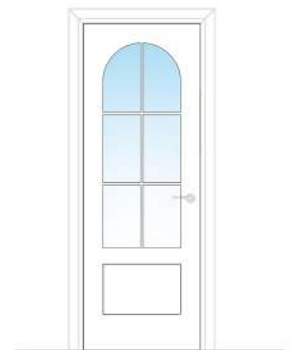

66 V TM

\_tipo de vidrieras  
\_types of glass door  
\_les types de portes en verre





32

\_roble  
\_oak  
\_chêne

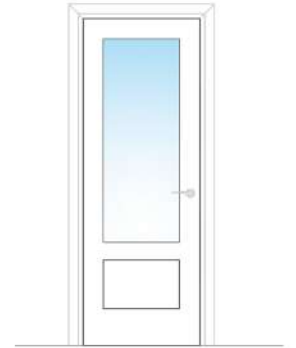

32 V

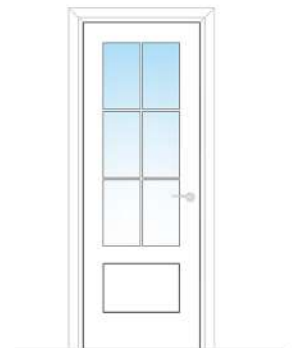

36 V

\_tipo de vidrieras  
\_types of glass door  
\_les types de portes en verre



## 72 TM

\_roble  
\_oak  
\_chêne

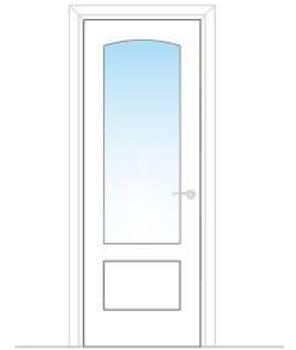

72 V TM

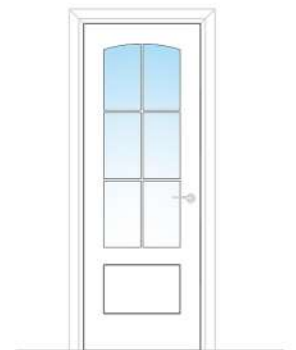

76 V TM

\_tipo de vidrieras  
\_types of glass door  
\_les types de portes en verre



72 ETM

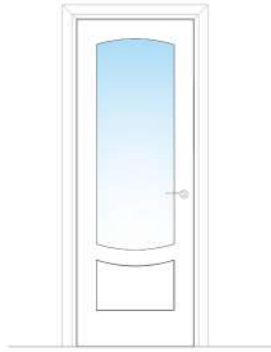

72 V ETM

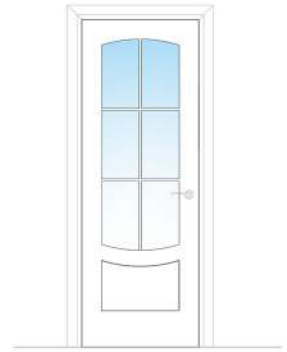

76 V ETM



72 ITM

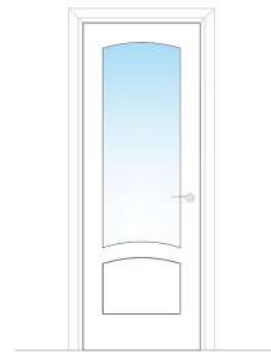

72 V ITM

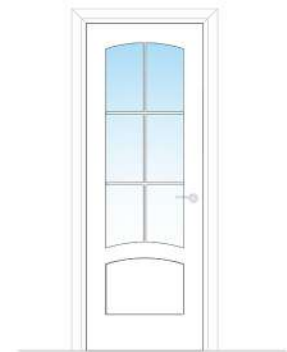

76 V ITM



# 104 TM

\_roble  
\_oak  
\_chêne

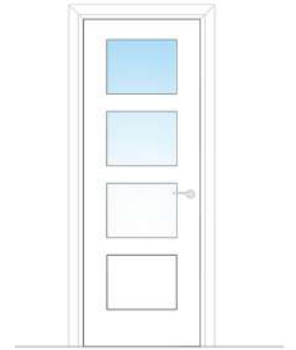

104 3V TM

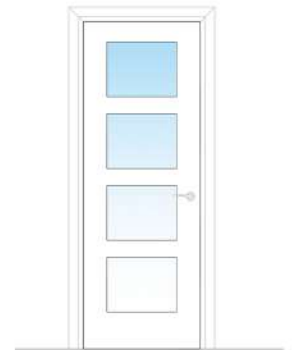

104 4V TM

\_tipo de vidrieras  
\_types of glass door  
\_les types de portes en verre



# 103 TM

\_roble  
\_oak  
\_chêne

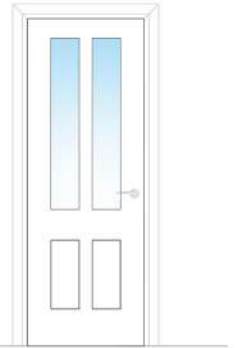

103 2V TM

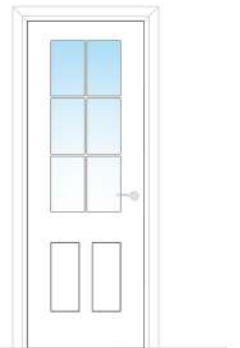

103 6V TM

\_tipo de vidrieras  
\_types of glass door  
\_les types de portes en verre



# 102 TM

\_cerezo  
\_cherry  
\_merisler



1103  
TM





B 2032 E

lacado blanco  
lacquered white  
- laqué blanc

serie  
**lacada**





## B 2103 FE

\_lacado blanco  
\_lacquered white  
\_laqué blanc

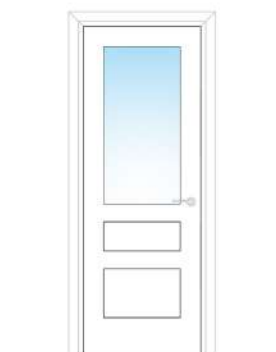

B 2103 FE IV

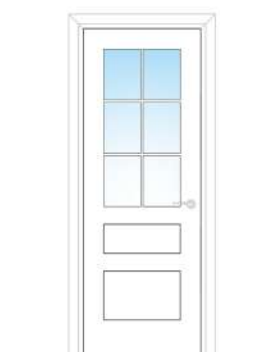

B 2103 FE 6V

\_tipo de vidrieras  
\_types of glass door  
\_les types de portes en verre



MODELO  
2000

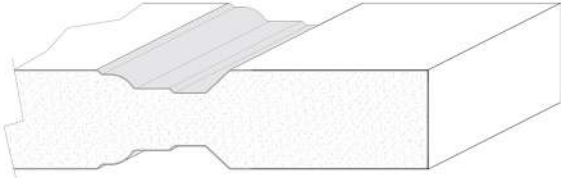

MODELO  
2000 R

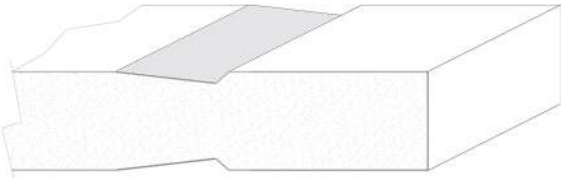



## B 2000 E

\_lacado blanco  
\_lacquered white  
\_laqué blanc

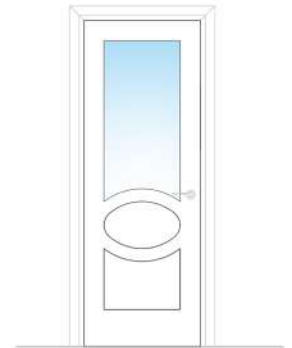

B 2000 E IV

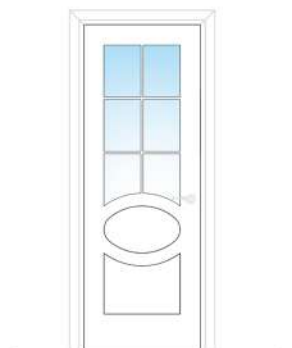

B 2000 E 6V

\_tipo de vidrieras  
\_types of glass door  
\_les types de portes en verre



B 2062 E

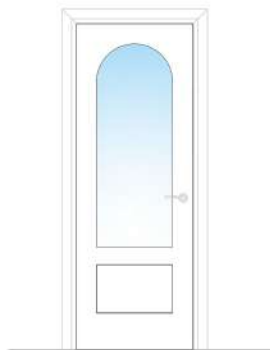

B 2062 V

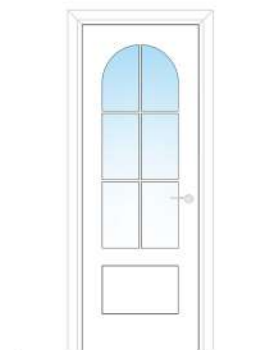

B 2066 V



B 2000 ER

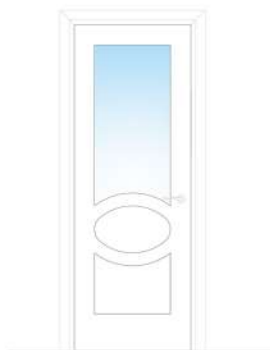

B 2000 ER IV

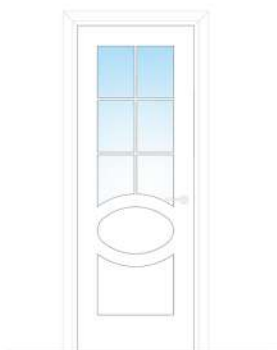

B 2000 ER 6V



## B 2052 E

\_lacado blanco  
\_lacquered white  
\_laqué blanc

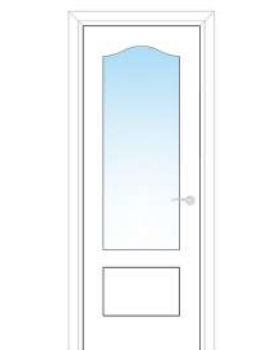

B 2052 V E

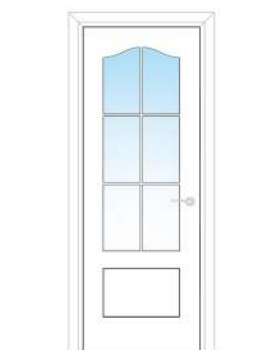

B 2056 V E

\_tipo de vidrieras  
\_types of glass door  
\_les types de portes en verre



## B 2072 E

\_lacado blanco  
\_lacquered white  
\_laqué blanc

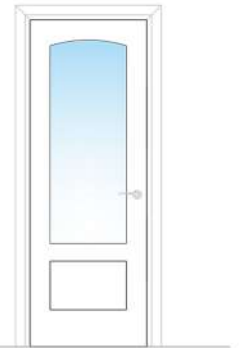

B 2072 V E

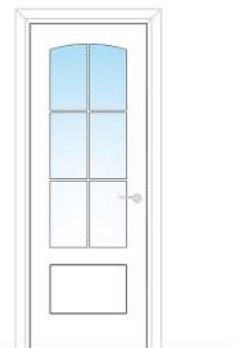

B 2076 V E

\_tipo de vidrieras  
\_types of glass door  
\_les types de portes en verre



## B 2106 E

\_lacado blanco  
\_lacquered white  
\_laqué blanc

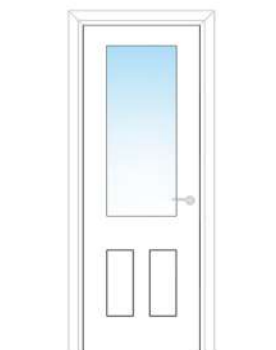

B 2106 E IV

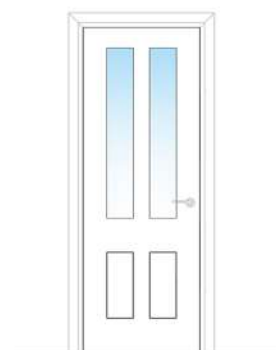

B 2106 E 2V

\_tipo de vidrieras  
\_types of glass door  
\_les types de portes en verre





B 2103 E

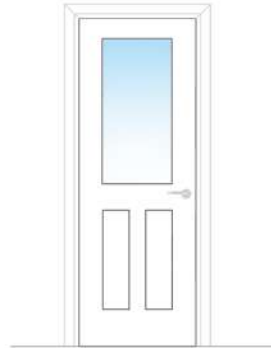

B 2103 E IV

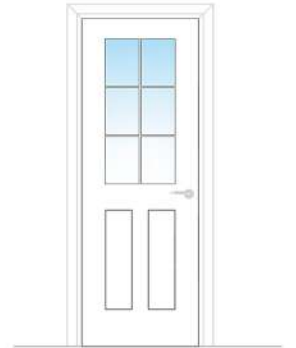

B 2103 E 6V



B 2106 ER

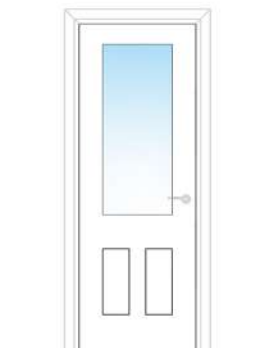

B 2106 ER IV

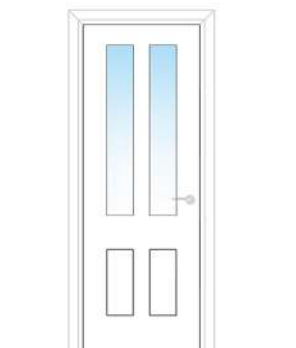

B 2106 ER 2V



## B 2032 E

\_lacado blanco  
\_lacquered white  
\_laqué blanc

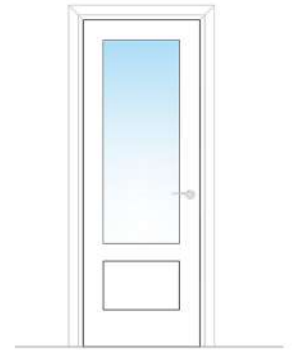

B 2032 V E

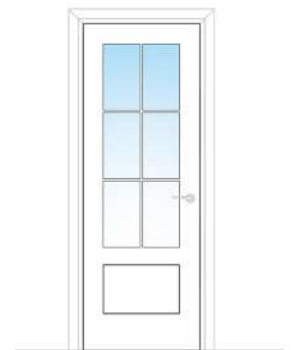

B 2036 V E

\_tipo de vidrieras  
\_types of glass door  
\_les types de portes en verre



B 2104 E

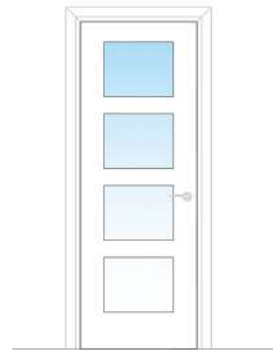

B 2104 E 4V



B 2032 ER

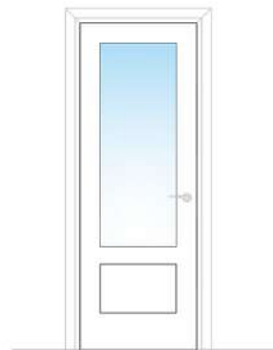

B 2032 V ER



B 2032 6V ER



# MAPI

\_lacado blanco  
\_lacquered white  
\_laqué blanc

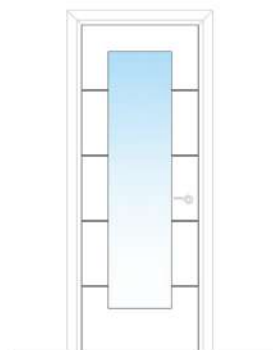

MAPI IV

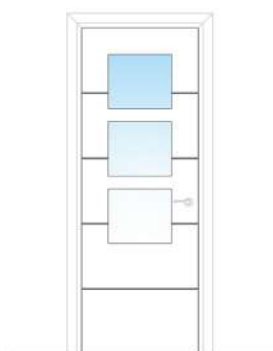

MAPI 3VLL

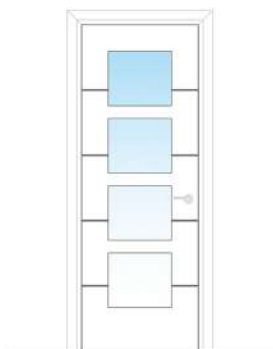

MAPI 4VLL

\_tipo de vidrieras  
\_types of glass door  
\_les types de portes en verre



MAHO

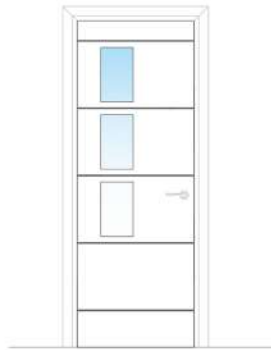

MAHO 3VL

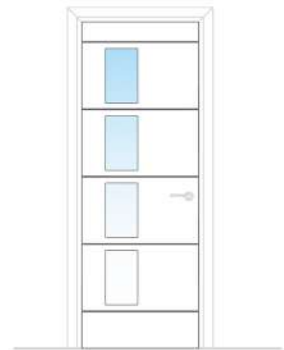

MAHO 4VL



LISA

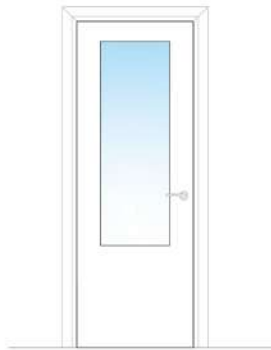

LISA IV

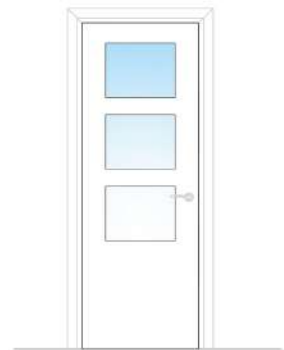

LISA 3VLL



# MARA

\_lacado blanco  
\_lacquered white  
\_laqué blanc

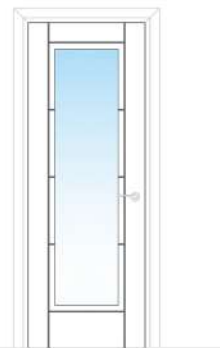

MARA IV

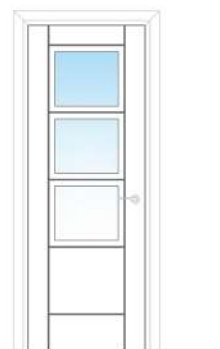

MARA 3VLL

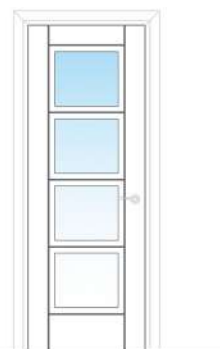

MARA 4VLL

\_tipo de vidrieras  
\_types of glass door  
\_les types de portes en verre



MAR 5

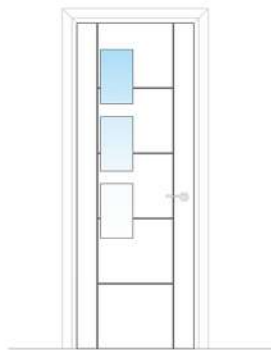

MAR 5 3VL

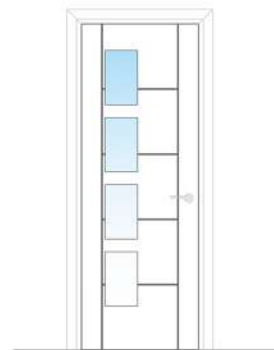

MAR 5 4VL



CALA

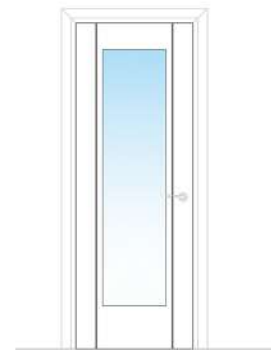

CALA IV

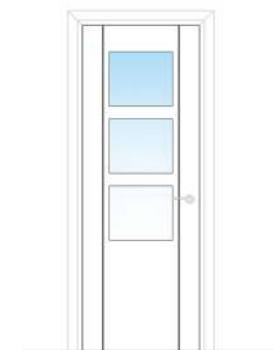

CALA 3VLL



EÑE

\_lacado blanco  
\_lacquered white  
\_laqué blanc



\_FRESADO EN PICO DE CORRIÓN  
sparrow beak milling / fraisage de bec de moineau

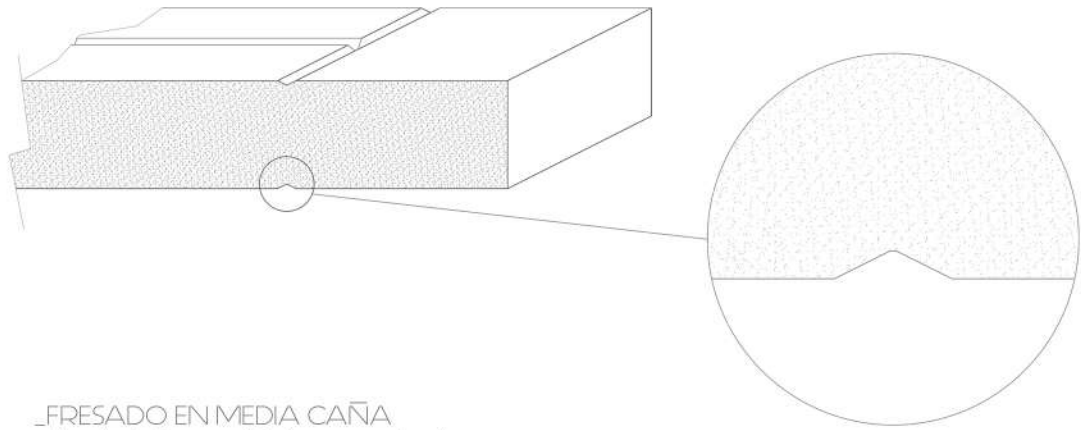

\_FRESADO EN MEDIA CAÑA  
milling in half cane / freisane en demi canne

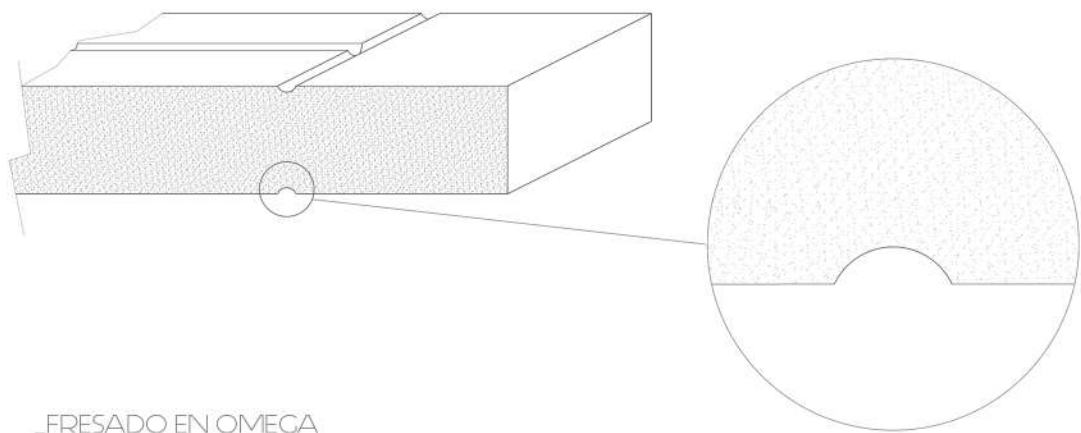

\_FRESADO EN OMEGA  
omega peak milling / fraisage de bec de omega

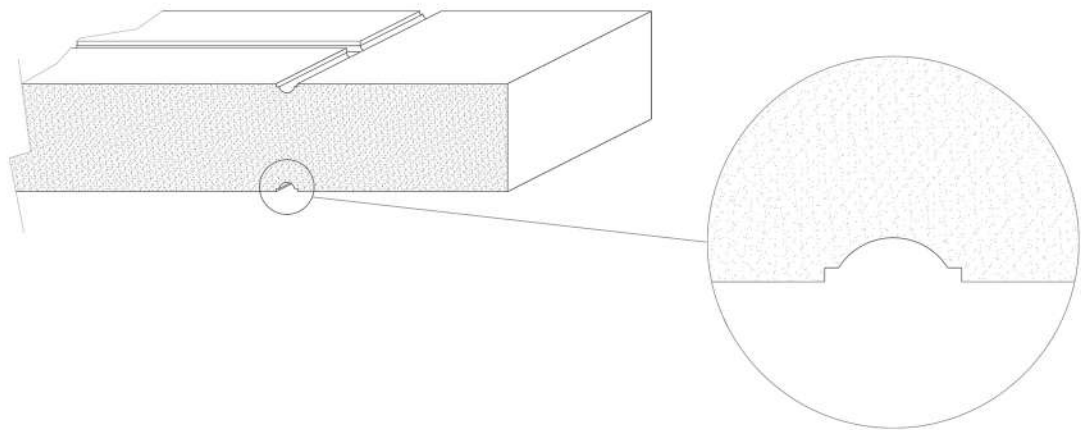



# LISA T SIBERIA

\_melaminado  
\_melamine  
\_mé laminé

serie

# melamina





# LISA T AHUMADO

\_melaminado  
\_melamine  
\_mé laminé

LISA NÓRDICO

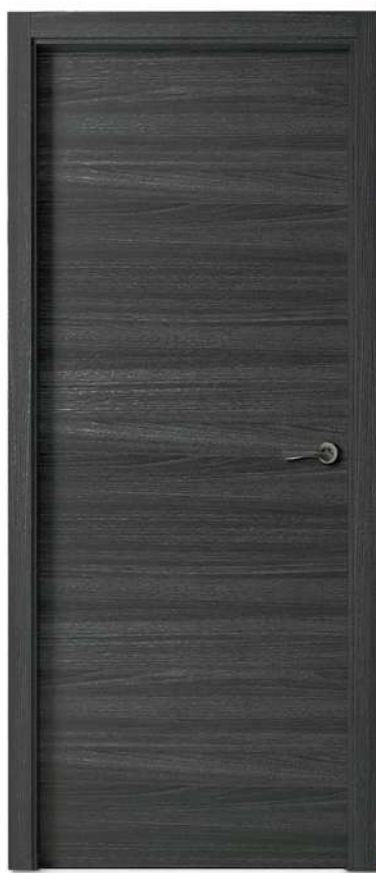

LISA T  
GRAFITO



LISA T NOGAL



LISA ROBLE

# ACABADOS EN MADERA NATURAL



Pino melix



Pino país



Haya blanca



Mukali



Haya vaporizada



Cerezo



Cedro



Oregon



Roble americano



Iroko



Sapelly dibujo



Etimœ



M'bero



Nogal americano



Castaño

# ACABADOS EN LACADO

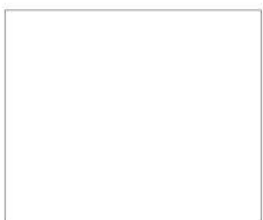

Blanco RAL :9003

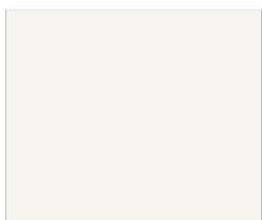

Beige RAL :9010

Para otros colores consultar.

For other colours, please ask for availability.

Pour les autres couleurs, vérifiez la disponibilité.

# ACABADOS EN ECO



Roble decape



Roble eco



Cerezo eco



Teka eco



Cebrano



Ebano eco



Gris claro

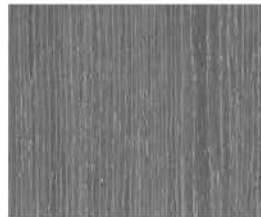

Gris ceniza



Wenge eco



Olmo negro

# ACABADOS EN MELAMINA



Nórdico



Siberia



Roble



Nogal



Ahumado



Grafito

Pedido min. 50 unid.

Minimum order, 50 units.

Commande min, 50 unit.

EI<sub>2</sub>30

EI<sub>2</sub>60

EI<sub>2</sub>30 dB

EI<sub>2</sub>60 dB

363







## PUERTAS RESISTENTES AL FUEGO Y CON ATENUACIÓN ACÚSTICA

**Homologadas por los diferentes laboratorios acreditados por ENAC, y en base a la Norma de Referencia del CTE.**

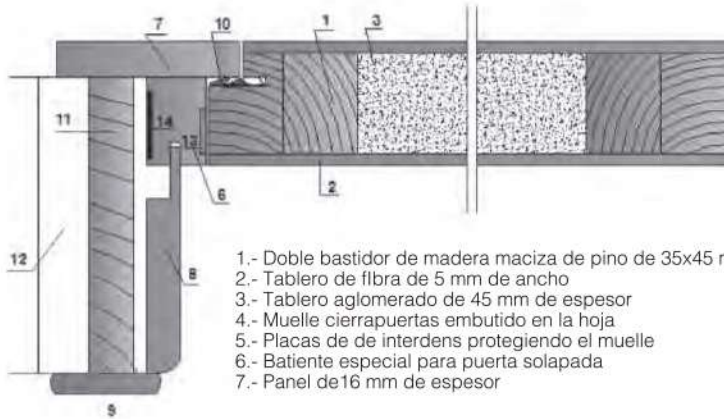

### BLOCK EI230 solapado

- 1.- Doble bastidor de madera maciza de pino de 35x45 mm
- 2.- Tablero de fibra de 5 mm de ancho
- 3.- Tablero aglomerado de 45 mm de espesor
- 4.- Muelle cierrapuertas embutido en la hoja
- 5.- Placas de de interdens protegiendo el muelle
- 6.- Batiente especial para puerta solapada
- 7.- Panel de 16 mm de espesor

- 8.- Embocadura de 16 mm de espesor
- 9.- Tapajuntad de 70x10-mm
- 10.- Burlete perimetral
- 11.- Prearco de madera de pino
- 12.- Tabique
- 13.- Palusol® encapsulado en vaina de PVC de 20x2-mm
- 14.- Intumescente grafito de 30x3-mm

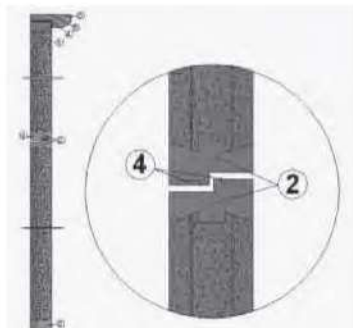

### BLOCK EI230 con montante superior

- 1.- Tablero aglomerado
- 2.- Recercado de madera maciza
- 3.- Cerco de tablero de fibra hidrófugo
- 4.- Intumescente colocado en el galce
- 5.- Intumescente colocado en cara posterior

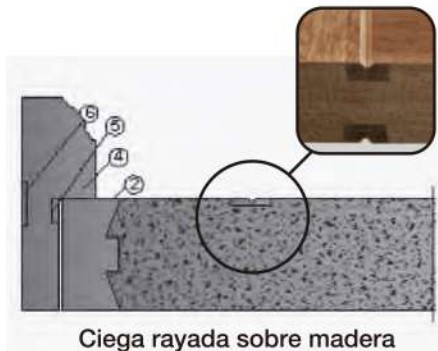

### BLOCK EI230 colección LINEAS

- 1.- Tablero aglomerado
- 2.- Recercado de madera maciza
- 3.- Moldura de madera maciza
- 4.- Cerco de tablero de fibra hidrófugo
- 5.- Intumescente colocado en el galce
- 6.- Intumescente colocado en cara posterior
- 7.- Protección perimetral del vidrio
- 8.- Vidrio Ei30-minutos

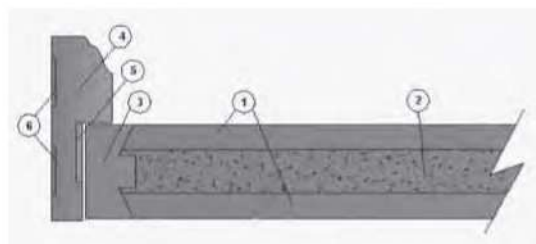

### BLOCK EI260 puerta LISA

- 1.- Tablero MDF ignífugo
- 2.- Tablero aglomerado ignífugo
- 3.- Recercado de madera maciza
- 4.- Cerco de tablero de fibra hidrófugo
- 5.- Intumescente colocado en el galce
- 6.- Intumescente colocado en cara posterior

## PUERTAS TÉCNICAS RESISTENTES AL FUEGO EI<sub>2</sub>30

Tipo de block de puerta	Homologación	Medidas	Expediente	Observaciones
LISA o LÍNEAS	EI <sub>2</sub> 30-c5	2110 x 925 x 45	240132	1 hoja, admite hoja vidriera (medida máxima de vidrio 1.02 medida <sup>2</sup> )
PLAFONADA (Lisa y con TM)	EI <sub>2</sub> 30-c5	2110 x 925 x 45	240132	1 hoja, admite hoja vidriera (medida máxima de vidrio 1.02 medida <sup>2</sup> )
MDF y/o PANTOGRAFIADA	EI <sub>2</sub> 30-c5	2110 x 925 x 45	240134/240160	1 hoja
LISA o LÍNEAS solapadas	EI <sub>2</sub> 30-c5	2110 x 925 x 50	270158	1 hoja

En puertas **EI<sub>2</sub>30-c5**, también existen certificaciones con acabados melamínicos.

También las puertas resistentes al fuego se pueden suministrar cajeadas con cerradura electrónica (ONITY, VINCARG, SALTO, TESA INHOVA y otras)

### Todos los productos homologados incorporan las siguientes características generales de los Blocks:

#### EI<sub>2</sub>30-c5

Hoja: Grueso de 45 mm  
 Cercos MDF: Mínimo 70x30  
 Tapajuntas MDF: 70x10  
 Bisagras de Hierro Latonado: 4 unidades IGLE o Similar  
 Cerradura antipánico 1 punto (TESA 4030 o similar) y Cierrapuertas TESA CT-1800  
 Medidas máximas: 2110 x 925 x 45 mm (máx 2200/1050)

#### EI<sub>2</sub>30-c5 BD

Hoja: Grueso de 45 mm  
 Cercos MDF: Mínimo 70x30  
 Tapajuntas MDF: 70x10  
 Bisagras de Hierro Latonado: 4 unidades ANTIPALANCA  
 Cerradura de 3 puntos, Cierrapuertas TESA CT-1800  
 Medidas máximas: 2110 x 925 x 45 mm (Otras medidas consultar)

## PUERTAS TÉCNICAS RESISTENTES AL FUEGO EI<sub>2</sub>60

Tipo de block de puerta	Homologación	Medidas	Expediente	Observaciones
LISA o LÍNEAS	EI <sub>2</sub> 60-c5	2110 x 925 x 55	228764	1 hoja, admite visor (medida máxima de vidrio 0.10 medida <sup>2</sup> )
PLAFONADA (LISA DECORADA)	EI <sub>2</sub> 30-c5	2110 x 925 x 45	228764	1 hoja, admite visor (medida máxima de vidrio 0.10 medida <sup>2</sup> )
PLAFONADA DOBLE	EI <sub>2</sub> 30-c5	2110 x 825 + 825 x 45	225505	2 hojas, admite visor (medida máxima de vidrio 0.10 medida <sup>2</sup> )
LISA o LÍNEAS DOBLES	EI <sub>2</sub> 30-c5	2110 x 825 + 825 x 45	225505	2 hojas, admite visor (medida máxima de vidrio 0.10 medida <sup>2</sup> )

### Todos los productos homologados incorporan las siguientes características generales en los Blocks:

#### EI<sub>2</sub>60-c5

Hoja: Grueso de 45 mm  
 Cercos MDF: Mínimo 90x30  
 Tapajuntas MDF: 70x10  
 Bisagras de Hierro Latonado: 4 unidades IGLE o Similar  
 Cerradura antipánico 1 punto (TESA 4030 o similar) y Cierrapuertas TESA CT-1800  
 Medidas máximas: 2110 x 925 x 45 mm

#### EI<sub>2</sub>60-c5 BD

Hoja: Grueso de 45 mm  
 Cercos MDF: Mínimo 90x30  
 Tapajuntas MDF: 70x10  
 Bisagras de Hierro Latonado: 4 unidades ANTIPALANCA  
 Cerradura de 3 puntos, Cierrapuertas TESA CT-1800  
 Medidas máximas: 2110 x 925 x 45 mm (Otras medidas consultar)



## PUERTAS TÉCNICAS RESISTENTES AL FUEGO Y CON ATENUACIÓN ACÚSTICA

Tipo de block de puerta	Homologación	Medidas	Expediente	Observaciones
LISA o LÍNEAS	EI230-c5 Acu. 30 dB(A)	2110x925x45	0526t05 0036 A07	1 hoja
PLAFONADA	EI230-c5 Acu. 30 dB(A)	2110x925x45	0526t05 0036 A07	1 hoja
LISA o LÍNEAS DOBLE Y VIDRIERA	EI230-c5 Acu. 26 dB(A)	2110x825+825x45	0526t05 0189 A10-1	1 hoja, admite hojas vidrieras (medida máxima de vidrio 1.02 m <sup>2</sup> )
LISA o LÍNEAS	EI245-c5 Acu. 40 dB(A)	2110x925x60	022A11-1	1 hoja
LISA o LÍNEAS	EI260-c5 Acu. 30 dB(A)	2110x925x45 0149 A09	1038T06	1 hoja

**Ensayos de aislamiento acústico realizados bajo la Norma UNE EN ISO 140-3:1995, "Medición a ruido aéreo en Laboratorio":**

### EI230-c5 Acoustic

Hoja: Grueso de 45 mm  
Cercos MDF: Mínimo 70x30  
Tapajuntas MDF: 70x10

Bisagras de Hierro Latonado: 4 unidades IGLE o Similar  
Cerradura antipánico 1 punto (TESA 4030 o similar) , Cierrapuertas TESA CT-1800  
Burlate Schelegel, Guillotina en la parte inferior Planet o similar  
Medidas máximas: 2110 x 925 x 45 mm (Otras medidas consultar)



"Solo los productos que aparecen identificados como tales en este documento están certificados FSC®"

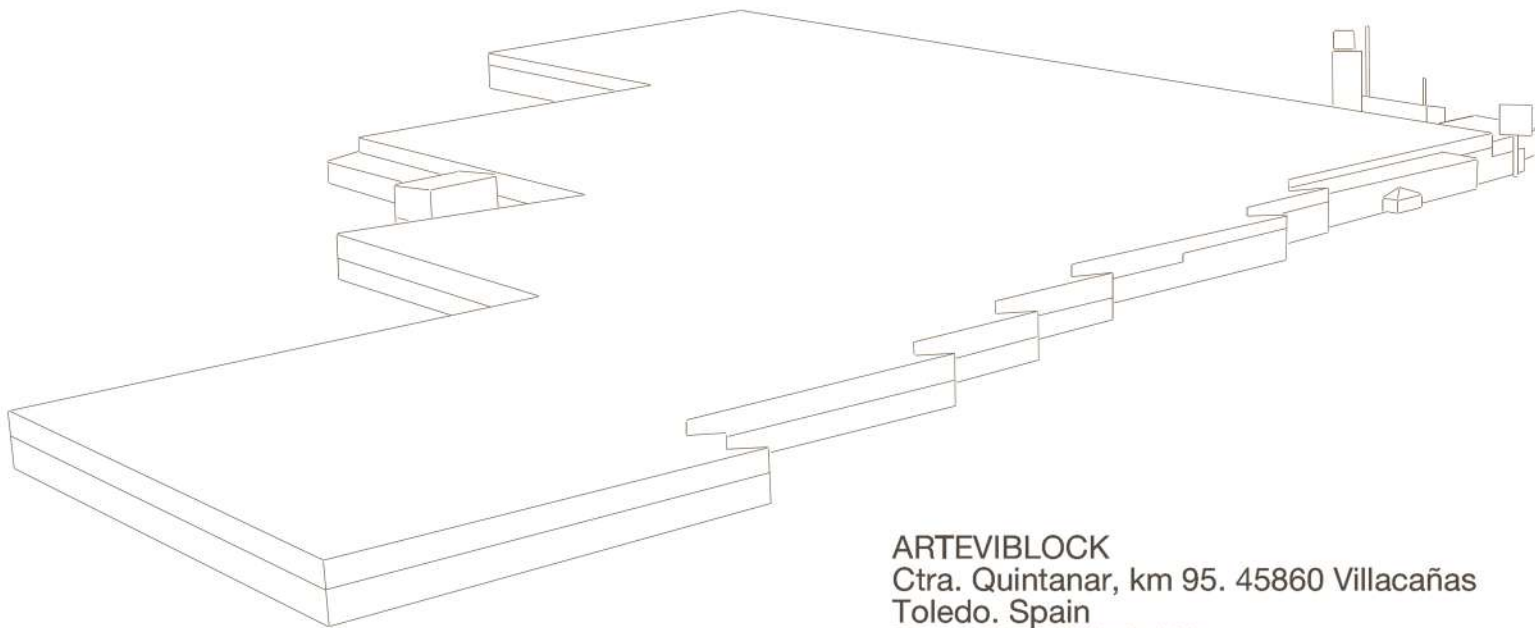

ARTEVIBLOCK  
Ctra. Quintanar, km 95. 45860 Villacañas  
Toledo. Spain  
Tel.: +34 925 950 900

[info@arteviblock.com](mailto:info@arteviblock.com)



[www.arteviblock.com](http://www.arteviblock.com)

